

EMTEK®

Cabinet & Bath  
**HARDWARE**





# Make a statement, your statement.

Emtek is dedicated to helping bring your personal style to life. Cabinet hardware is more than a way to open, close and secure your space. To us, it is an integral part of a room's design theme. Cabinet hardware should make a statement, your statement.

With decorative products that are a cut above in terms of craftsmanship and design, each order is assembled with care in our Southern California facility.

Founded in 1981, Emtek has decades of experience designing and creating hardware solutions. We keep our finger on the pulse of the market and regularly release new designs. Our style is current, but we never forget about the classics. From traditional to contemporary, transitional or rustic, we have hardware to match every style.

In this brochure, you will find examples of Emtek's extensive range of cabinet and bath hardware. To see Emtek's complete product offerings, visit **Emtek.com** or your local Emtek dealer.

# FINISH OPTIONS



Polished Brass  
(US3)



Polished Brass -  
Lifetime (US3)

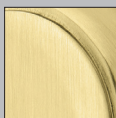

Satin Brass  
(US4)



French Antique  
(US7)

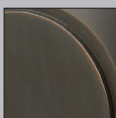

Oil Rubbed Bronze  
(US10B)



Polished Nickel  
(US14)



Polished Nickel -  
Lifetime (US14)



Satin Nickel  
(US15)



Pewter  
(US15A)



Flat Black  
(US19)



Polished Chrome  
(US26)

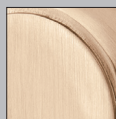

Satin Copper  
(SCU)



Flat Black Bronze  
Patina (FB)



Medium Bronze  
Patina (MB)



Tumbled White  
Bronze (TWB)

**Bronze Patina** is a living finish that will gracefully age, revealing the underlying bronze over time. Because of this characteristic, no finish warranty is offered on bronze patina products.

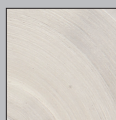

Brushed Stainless  
Steel (SS)

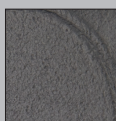

Flat Black Steel  
(FBS)

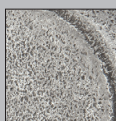

Satin Steel  
(SWS)

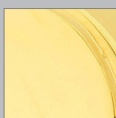

Unlacquered Brass  
(US3NL)

**Unlacquered Brass (US3NL)** is a custom, made-to-order finish. It is available with an upcharge, per item and requires an additional 2-3 day lead time. This living finish will gracefully age and evolve in appearance over time. Because of this characteristic, no finish warranty is offered on unlacquered brass products.

## CABINET HARDWARE

SELECT Cabinet Pull	6
SELECT Appliance Pull	8
SELECT Cabinet Knob & Edge Pull	10
Modern Backplate	12
Modern Edge Pull	13
Industrial Modern	14
Modern Rectangular	16
Urban Modern	18
Geometric	20
Contemporary	22
Carbon Fiber	26
Mid Century Modern	28
Art Deco	30
Hollywood Regency	32
Timeless Classics	34
Transitional Heritage	36
Cabinet Latch	38
Traditional	39
Arts & Crafts	42
Ribbon & Reed	44
Glass	46
Stainless Steel	54
Rustic Modern	56
Sandcast Bronze	58
Tuscany Bronze	62
Wrought Steel	66
Appliance Pulls	68

## BATH HARDWARE

Modern	74
Transitional	75
Traditional	76
Sandcast Bronze	78
Tuscany Bronze	80
Wrought Steel	82
Stainless Steel	83



## EMTEK SELECT

DESIGNED TO BE PERSONALIZED

---

Mix-Match Style & Finish  
for stems and bar pulls:

- 1 stem design in 7 finishes
- 2 bar pull designs in 7 finishes



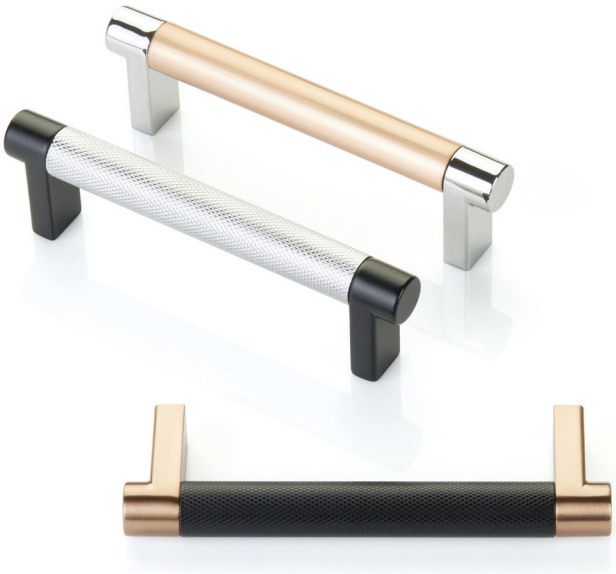

**SELECT Cabinet Pull**

Product Code	C-to-C	Overall	Projection
84052	3 1/2"	4 1/4"	1 3/8"
84053	4"	4 3/4"	1 3/8"
84054	5"	5 3/4"	1 3/8"
84055	6"	6 3/4"	1 3/8"
84056	8"	8 3/4"	1 3/8"
84057	10"	10 3/4"	1 3/8"
84058	12"	12 3/4"	1 3/8"

**SELECT Cabinet Pull**

Finish Options:



US4

US10B

US14

US15

US19

US26

SCU





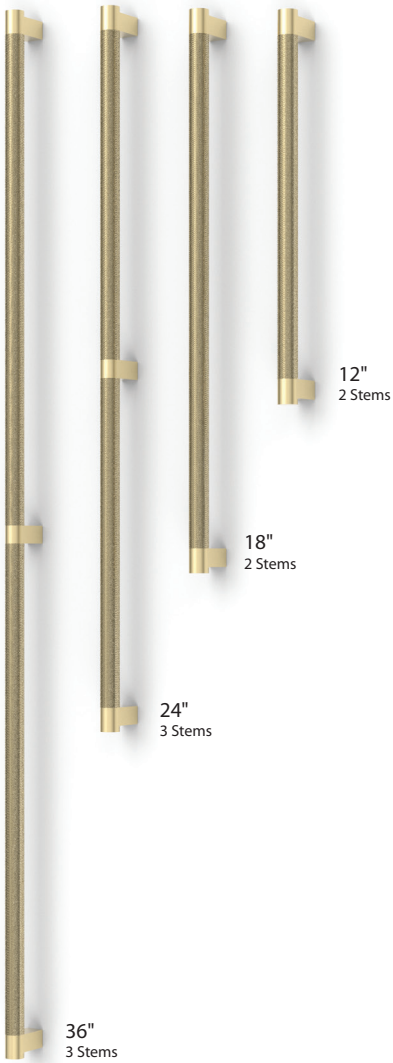

# SELECT Appliance Pull

## SELECT Appliance Pull

Product Code	C-to-C	Overall	Width	Projection
84070	12"	12 <sup>7</sup> / <sub>8</sub> "	1"	2"
84071	18"	18 <sup>7</sup> / <sub>8</sub> "	1"	2"
84072	24"	24 <sup>7</sup> / <sub>8</sub> "	1"	2"
84073	36"	36 <sup>7</sup> / <sub>8</sub> "	1"	2"

### Finish Options:



US4

US10B

US14

US15

US19

US26

SCU

# 10

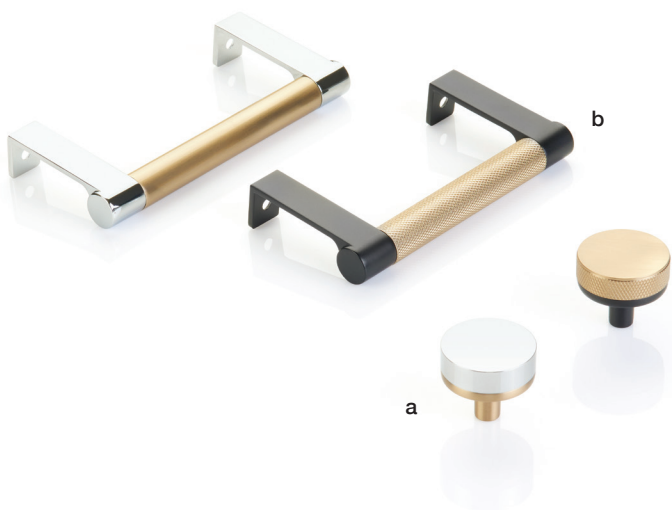

### a. SELECT Cabinet Knob

Product Code	Dimension	Projection
86655	1 ¼"	1"

### b. SELECT Cabinet Edge Pull

Product Code	C-to-C	Overall	Projection
84080	3 ¾"	4 ½"	2 ¼"
84081	4 ¼"	5"	2 ¼"
84082	5 ¼"	6"	2 ¼"
84083	6 ¼"	7"	2 ¼"
84084	8 ¼"	9"	2 ¼"
84085	10 ¼"	11"	2 ¼"
84086	12 ¼"	13"	2 ¼"

Finish Options:



US4

US10B

US14

US15

US19

US26

SCU



SELECT Cabinet Knob & Edge Pull



# Modern Backplate

## a. Modern Backplate For Pull

Product Code	C-to-C	W x H	Depth
86922	4"	5 ¼" x 1"	¾"
86923	5"	6 ¼" x 1"	¾"
86924	6"	7 ¼" x 1"	¾"
86925	8"	9 ¼" x 1"	¾"
86926	10"	11 ¼" x 1"	¾"
86927	12"	13 ¼" x 1"	¾"

## b. Modern Backplate For Knob

Product Code	W x H	Depth
86921	4" x 1"	¾"

Finish Options:



US4



US10B



US14



US15



US19



US26



### c. Modern Edge Pull

Product Code	C-to-C	Overall	Projection
87160	1"	1 1/2"	1 3/4"
87100	3"	4 1/4"	1 3/4"
87110	4"	5 1/4"	1 3/4"
87120	6"	7 1/4"	1 3/4"
87130	8"	9 1/4"	1 3/4"
87140	10"	11 1/4"	1 3/4"
87150	12"	13 1/4"	1 3/4"

# Modern Edge Pull

#### Finish Options:



US4



US10B



US14



US15



US19



US26



### a. Haydon Knob

Product Code	Dimension	Projection
86697	1 ¼"	1 ⅛"
86698	1 ¾"	1 ½"

### b. Brandt Knob

Product Code	Dimension	Projection
86695	1 ¼"	1 ¼"
86696	1 ¾"	1 ½"

#### Finish Options:



US4



US10B



US14



US15



US19



US26



### c. Jasper Pull

Product Code	C-to-C	Overall	Projection
86686	3 1/2"	4 3/8"	1 3/8"
86687	4"	4 7/8"	1 3/8"
86688	5"	5 7/8"	1 3/8"
86689	6"	6 7/8"	1 3/8"
86690	8"	8 7/8"	1 3/8"
86691	10"	10 7/8"	1 3/8"
86692	12"	12 7/8"	1 3/8"

### d. Jasper Finger Pull

Product Code	Overall	Width	Projection
86699	2"	1/2"	1 3/8"

Industrial Modern

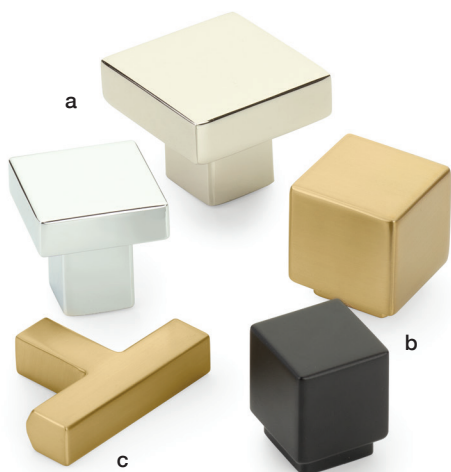

### a. Hunter Knob

Product Code	Dimension	Projection
86702	1 ¼"	1 ¼"
86703	1 ⅝"	1 ¼"

### b. Allerton Knob

Product Code	Dimension	Projection
86700	1"	1 ¼"
86701	1 ⅝"	1 ¼"

### c. Warwick T-Knob

Product Code	Overall	Projection	Width
86726	2"	1 ⅜"	½"

#### Finish Options:



US4



US10B



US14



US15



US19



US26



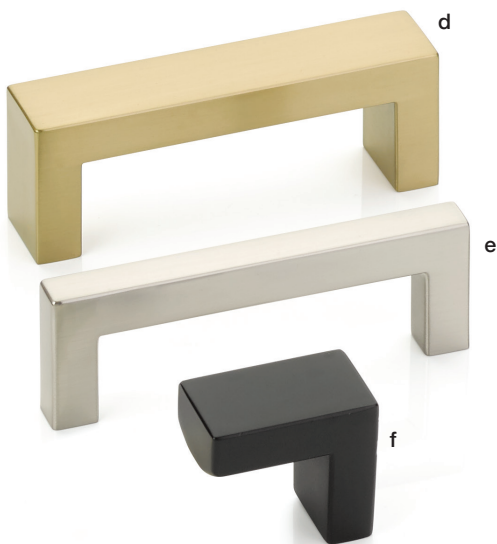

#### d. Keaton Pull

Product Code	C-to-C	Overall	Projection	Width
86714	3 1/2"	4"	1 1/2"	7/8"
86715	4"	4 1/2"	1 1/2"	7/8"
86716	5"	5 1/2"	1 1/2"	7/8"
86717	6"	6 1/2"	1 1/2"	7/8"
86718	8"	8 1/2"	1 1/2"	7/8"
86719	10"	10 1/2"	1 1/2"	7/8"
86720	12"	12 1/2"	1 1/2"	7/8"

#### e. Warwick Pull

Product Code	C-to-C	Overall	Projection	Width
86704	3 1/2"	4"	1 3/8"	1/2"
86705	4"	4 1/2"	1 3/8"	1/2"
86706	5"	5 1/2"	1 3/8"	1/2"
86707	6"	6 1/2"	1 3/8"	1/2"
86708	8"	8 1/2"	1 3/8"	1/2"
86709	10"	10 1/2"	1 3/8"	1/2"
86710	12"	12 1/2"	1 3/8"	1/2"

#### f. Keaton Finger Pull

Product Code	Overall	Projection	Width
86713	1 1/2"	1 1/2"	7/8"

Modern Rectangular



### a. Mod Hex Knob

Product Code	Dimension	Projection
86457	1 1/8"	1 1/4"
86458	1 1/2"	1 3/8"

### b. Freestone Knob

Product Code	Dimension	Projection
86450	1 1/4"	1 1/4"
86451	1 1/2"	1 1/4"

### c. Freestone T-Knob

Product Code	Overall	Projection	Width
86727	2"	1 1/8"	1/2"

### d. Cinder Knob

Product Code	Dimension	C-to-C	Projection
86446	1 5/8"	1"	7/8"
86447	2 1/4"	1"	1"

### e. District Knob

Product Code	Dimension	Projection
86448	1 3/8"	5/8"
86449	1 5/8"	5/8"

### f. Mod Hex T-Knob

Product Code	Overall	Projection
86728	2"	1 1/4"

### g. Mod Hex Extended Pull

Product Code	C-to-C	Overall	Projection
86684	3 1/2"	7"	1 1/4"
86685	6"	10 1/2"	1 3/8"

Finish Options:



US4



US10B



US14



US15



US19



US26



### **h. Mod Hex Pull**

Product Code	C-to-C	Overall	Projection
86459	3 1/2"	5 3/8"	1 1/4"
86460	4"	5 3/4"	1 1/4"
86679	5"	7"	1 3/8"
86461	6"	8"	1 3/8"
86462	8"	10 1/4"	1 3/8"
86680	10"	12 1/4"	1 3/8"
86681	12"	14 1/4"	1 3/8"

### **i. Freestone Extended Pull**

Product Code	C-to-C	Overall	Projection
86682	3 1/2"	7"	1 1/4"
86683	6"	10 1/2"	1 3/8"

### **j. Freestone Pull**

Product Code	C-to-C	Overall	Projection
86453	3 1/2"	4 3/4"	1 1/4"
86454	4"	5 1/4"	1 1/4"
86676	5"	6 3/4"	1 3/8"
86455	6"	7 3/4"	1 3/8"
86456	8"	10 1/2"	1 3/8"
86677	10"	12 1/2"	1 3/8"
86678	12"	14 1/2"	1 3/8"

### **k. Freestone Finger Pull**

Product Code	Overall	Width	Projection
86452	1 7/8"	1/2"	1 1/8"

Urban Modern



### a. Geometric Rectangular Pull

Product Code	C-to-C	Overall	Projection
86299	3"	4 1/4"	1 1/8"
86300	3 1/2"	4 5/8"	1 1/8"
86301	4"	5 1/4"	1 1/8"
86492	5"	6 1/4"	1 1/8"
86302	6"	7 1/4"	1 1/8"
86303	10"	11 1/4"	1 1/8"
86493	12"	13 1/4"	1 1/8"

#### Finish Options:



US4



US10B



US14



US15



US19



US26

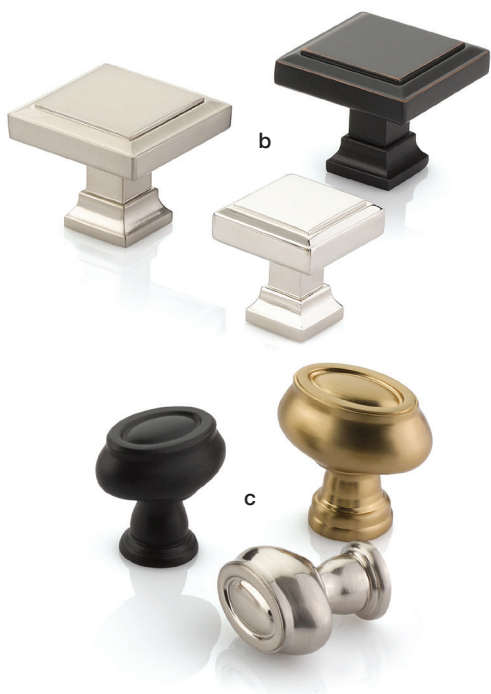

### **b. Geometric Square Knob**

Product Code	Dimension	Projection
86295	1 1/4"	1 1/4"
86296	1 5/8"	1 3/8"

### **c. Geometric Oval Knob**

Product Code	Dimension	Projection
86304	1 1/4"	1 1/4"
86305	1 1/2"	1 1/2"
86306	1 3/4"	1 1/2"

**Geometric**

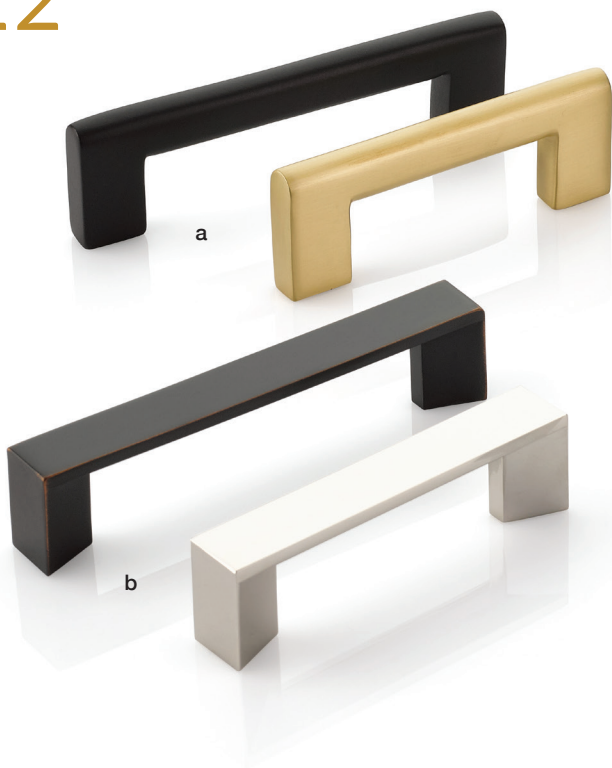

### a. Trail Pull

Product Code	C-to-C	Overall	Projection
86161	3"	3 3/4"	1 3/8"
86162	3 1/2"	4 1/4"	1 3/8"
86163	4"	4 3/4"	1 3/8"
86272	5"	5 3/4"	1 3/8"
86164	6"	6 3/4"	1 3/8"
86165	8"	8 3/4"	1 3/8"
86273	10"	10 3/4"	1 3/8"
86166	12"	12 3/4"	1 3/8"
86274	16"	16 3/4"	1 3/8"

### b. Trinity Pull

Product Code	C-to-C	Overall	Projection
86263	3"	3 1/2"	1"
86264	3 1/2"	4"	1"
86265	4"	4 1/2"	1"
86482	5"	5 1/2"	1"
86266	6"	6 1/2"	1"
86438	8"	8 1/2"	1"
86267	10"	10 1/2"	1"
86483	12"	12 1/2"	1"



### c. Metric Knob

Product Code	Dimension	Projection
86268	1"	1 1/4"
86269	1 1/8"	1 3/8"

### d. Cone Knob

Product Code	Dimension	Projection
86261	1"	1 1/8"
86262	1 1/8"	1 3/8"

### e. Finger Pull

Product Code	Dimension	Projection
86150	7/8"	1"
86151	1"	1 1/4"

### f. Trail Knob

Product Code	Dimension	Projection
86271	2"	1 3/8"

#### Finish Options:



US4

US10B

US14

US15

US19

US26

US3NL\*

\*US3NL is NOT available for Trinity Pull.

800.356.2741

Contemporary



### a. Globe Knob

Product Code	Dimension	Projection
86152	1 1/8"	1 1/2"

### b. Orbit Pull

Product Code	C-to-C	Overall	Projection
86256	3"	3 3/8"	1"
86257	3 1/2"	3 7/8"	1"
86258	4"	4 3/8"	1"
86259	6"	6 3/8"	1"
86260	10"	10 3/8"	1"

### c. Ring Knob

Product Code	C-to-C	Projection
86270	1"	1 1/4"



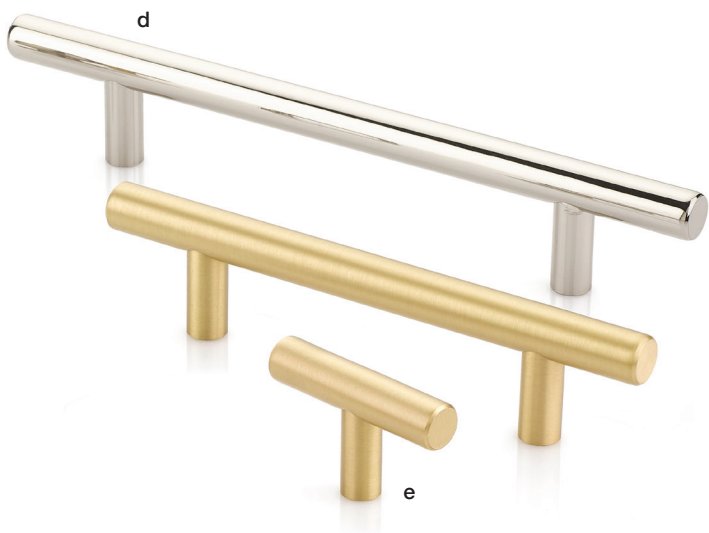

### d. Bar Pull

Product Code	C-to-C	Overall	Projection
86358	3"	5"	1 1/4"
86359	3 1/2"	5 1/2"	1 1/4"
86360	4"	6 1/2"	1 1/4"
86361	5"	7 1/2"	1 1/4"
86362	6"	8 1/2"	1 1/4"
86363	8"	10 1/2"	1 1/4"
86364	10"	12 1/2"	1 1/4"
86365	12"	14 1/2"	1 1/4"
86366	16"	18 1/2"	1 1/4"
86367	24"	26 1/2"	1 1/4"

### e. Bar Knob

Product Code	Dimension	Projection
86357	2"	1 1/4"

### Finish Options:



US4

US10B

US14

US15

US19

US26

US3NL

Contemporary

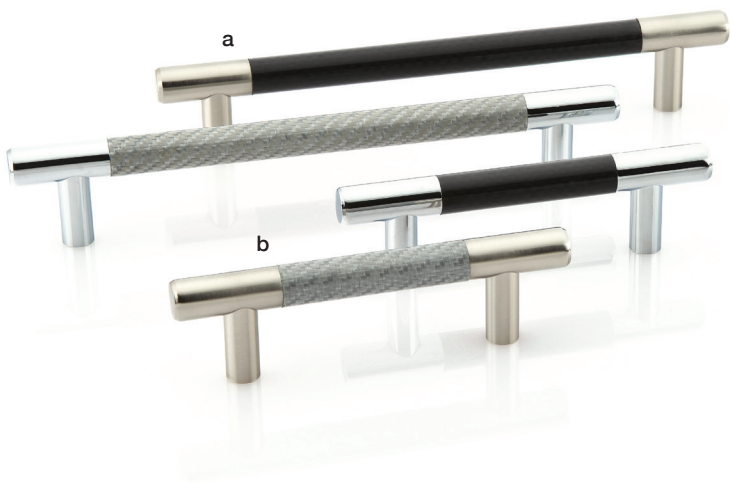

Discontinued with Inventory. Call for Availability.

#### a. Carbon Fiber Bar Pull - Black

Product Code	C-to-C	Overall	Projection
86376	3"	4 1/2"	1 1/4"
86377	3 1/2"	5"	1 1/4"
86378	4"	5 1/2"	1 1/4"
86379	5"	6 1/2"	1 1/4"
86380	6"	7 1/2"	1 1/4"
86381	8"	9 1/2"	1 1/4"
86382	10"	11 1/2"	1 1/4"
86383	12"	13 1/2"	1 1/4"
86384	16"	17 1/2"	1 1/4"

#### b. Carbon Fiber Bar Pull - Silver

Product Code	C-to-C	Overall	Projection
86385	3"	4 1/2"	1 1/4"
86386	3 1/2"	5"	1 1/4"
86387	4"	5 1/2"	1 1/4"
86388	5"	6 1/2"	1 1/4"
86389	6"	7 1/2"	1 1/4"
86390	8"	9 1/2"	1 1/4"
86391	10"	11 1/2"	1 1/4"
86392	12"	13 1/2"	1 1/4"
86393	16"	17 1/2"	1 1/4"



### c. Carbon Fiber Bin Pull - Black

Product Code	C-to-C	Overall	Projection
86372	3"	3 <sup>3</sup> / <sub>8</sub> "	1"
86373	4"	4 <sup>3</sup> / <sub>8</sub> "	1"

### d. Carbon Fiber Bin Pull - Silver

Product Code	C-to-C	Overall	Projection
86374	3"	3 <sup>3</sup> / <sub>8</sub> "	1"
86375	4"	4 <sup>3</sup> / <sub>8</sub> "	1"

### e. Carbon Fiber Knob - Silver

Product Code	Dimension	Projection
86370	1 <sup>1</sup> / <sub>4</sub> "	1 <sup>3</sup> / <sub>8</sub> "
86371	1 <sup>5</sup> / <sub>8</sub> "	1 <sup>1</sup> / <sub>2</sub> "

### f. Carbon Fiber Knob - Black

Product Code	Dimension	Projection
86368	1 <sup>1</sup> / <sub>4</sub> "	1 <sup>3</sup> / <sub>8</sub> "
86369	1 <sup>5</sup> / <sub>8</sub> "	1 <sup>1</sup> / <sub>2</sub> "

Finish Options:



US15



US26

Carbon Fiber



### a. Cadet Knob

Product Code	Dimension	Projection
86321	1"	1 1/8"
86322	1 1/4"	1 1/8"
86323	1 3/4"	1 3/8"

### b. Atomic Knob

Product Code	Dimension	Projection
86314	1"	1 1/4"
86315	1 1/4"	1 1/4"
86316	1 5/8"	1 1/2"

### c. Basin Knob

Product Code	Dimension	Projection
86317	1 1/4"	3/4"
86318	1 5/8"	1"

### d. Podium Knob

Product Code	Dimension	Projection
86319	1 1/4"	1 1/8"
86320	1 3/4"	1 3/8"



### e. Bauhaus Pull

Product Code	C-to-C	Overall	Projection
86324	3"	3 3/8"	1 1/8"
86325	4"	4 3/8"	1 1/8"

### f. Dane Pull

Product Code	C-to-C	Overall	Projection
86309	3"	3 3/8"	1 1/2"
86310	3 1/2"	3 7/8"	1 1/2"
86311	4"	4 3/8"	1 1/2"
86312	6"	6 3/8"	1 1/2"
86313	10"	10 3/8"	1 1/2"

#### Finish Options:



US4



US10B



US14



US15



US19



US26

Mid Century Modern

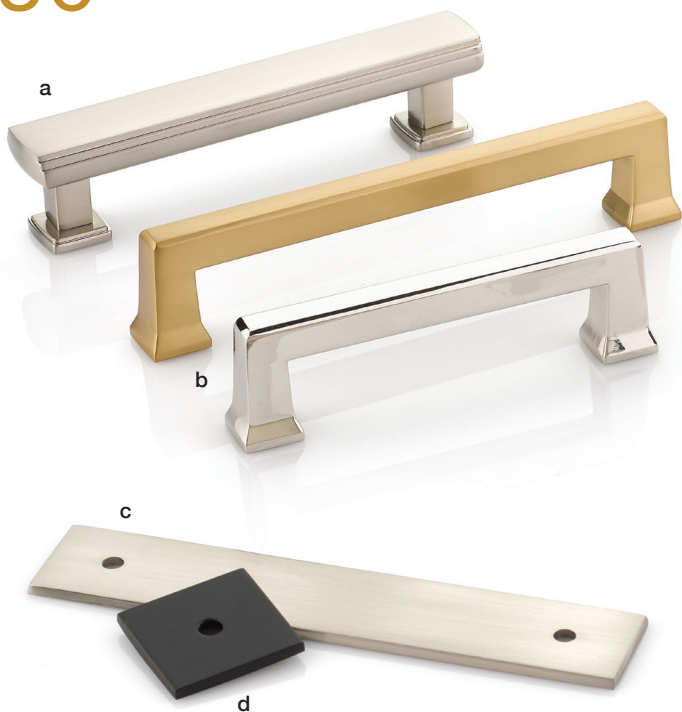

### a. Art Deco Pull

Product Code	C-to-C	Overall	Projection
86422	3 1/2"	4 3/8"	1 1/8"
86423	4"	4 7/8"	1 1/8"

### b. Alexander Pull

Product Code	C-to-C	Overall	Projection
86424	3 1/2"	4 1/8"	1 1/8"
86425	4"	4 5/8"	1 1/8"
86484	5"	5 5/8"	1 1/8"
86426	6"	6 5/8"	1 1/8"
86427	8"	8 5/8"	1 1/8"
86485	10"	10 5/8"	1 1/8"
86479	12"	12 5/8"	1 1/8"

### c. Rectangular Back Plate for Pull

Product Code	C-to-C	Overall	Thickness
86435	4"	5 1/4" x 1"	1/8"

### d. Square Back Plate for Knob

Product Code	Dimension	Thickness
86434	1 1/4"	1/8"



### e. Tribeca Pull

Product Code	C-to-C	Overall	Projection
86428	3 1/2"	5 1/2"	1 1/4"
86429	4"	6"	1 1/4"
86489	5"	7"	1 1/4"
86430	6"	8"	1 1/4"
86431	8"	10"	1 1/4"
86490	10"	12"	1 3/8"
86491	12"	14"	1 3/8"

### f. Art Deco Knob

Product Code	Dimension	Projection
86421	1 1/4"	1 1/4"

### g. Tribeca T-Knob

Product Code	Overall	Projection
86729	2"	1 3/8"

### h. Newport Knob

Product Code	Dimension	Projection
86432	1 1/4"	1 1/4"
86433	1 3/4"	1 1/2"

Finish Options:



US4



US10B



US14



US15



US19



US26

Art Deco

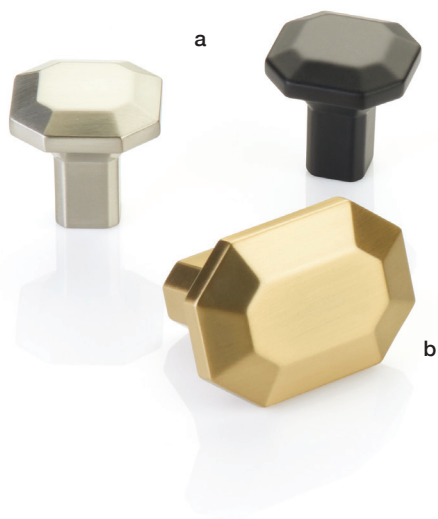

### a. Riviera Square Knob

Product Code	Dimension	Projection
86612	1 ¼"	1 ¼"

### B. Riviera Rectangular Knob

Product Code	Dimension	Projection
86613	2" x 1 ⅜"	1 ½"





### c. Riviera Pull

Product Code	C-to-C	Overall	Projection
86614	3 ½"	4"	1 ½"
86615	4"	4 ½"	1 ½"
86616	5"	5 ½"	1 ½"
86617	6"	6 ½"	1 ½"
86618	8"	8 ½"	1 ½"
86619	10"	10 ½"	1 ½"
86620	12"	12 ½"	1 ½"

#### Finish Options:



US4



US10B



US14



US15



US19



US26

# Hollywood Regency

**a. Paxton Knob**

Product Code	Dimension	Projection
86642	1 ¼"	1"

**b. Lawson Knob**

Product Code	Dimension	Projection
86643	1 ¼"	1"

**c. Kenter Knob**

Product Code	Dimension	Projection
86644	1 ¼"	1"



### d. Westridge Pull

Product Code	C-to-C	Overall	Projection
86633	3 1/2"	4 1/4"	1 1/4"
86634	4"	4 3/4"	1 1/4"
86635	5"	5 3/4"	1 1/4"
86636	6"	6 3/4"	1 1/4"
86637	8"	8 3/4"	1 1/4"
86638	10"	10 3/4"	1 1/4"
86639	12"	12 3/4"	1 1/4"

Timeless Classics

#### Finish Options:



US4



US10B



US14



US15



US19



US26



### a. Overland Knob

Product Code	Dimension	Projection
86467	1 1/4"	1 1/4"
86468	1 3/4"	1 1/2"

### b. Westwood Pull

Product Code	C-to-C	Overall	Projection
86475	3 1/2"	4 1/4"	1 1/8"
86476	4"	4 5/8"	1 1/8"
86477	6"	6 5/8"	1 1/8"
86478	8"	8 5/8"	1 1/4"

### c. Prosser Knob

Product Code	Dimension	Projection
86469	1"	1 1/4"
86470	1 1/4"	1 3/8"

#### Finish Options:



US4



US10B



US14



US15



US19



US26



### d. Blythe Pull

Product Code	C-to-C	Overall	Projection
86471	3 1/2"	4 1/4"	1 1/4"
86472	4"	4 3/4"	1 1/4"
86473	6"	6 5/8"	1 3/8"
86474	8"	8 5/8"	1 1/2"

### e. Midvale Knob

Product Code	Dimension	Projection
86465	1 1/4"	1"
86466	1 3/4"	1 1/4"

### f. Glendon Knob

Product Code	Dimension	Projection
86463	1 1/4"	1 1/4"
86464	1 5/8"	1 1/2"

Transitional Heritage



# Cabinet Latch

## a. Cabinet Latch

Product Code	Overall	Projection
2270	2" x 2 1/4"	1 3/8"

### Finish Options:



US3



US4



US7



US10B



US14



US15



US15A



US19



US26



US3NL



### b. Rope Knob

Product Code	Dimension	Projection
86112	1"	1"
86113	1 1/4"	1 1/4"
86202	1 3/4"	1 1/2"

### c. Melon Knob

Product Code	Dimension	Projection
86121	1"	1"
86122	1 1/4"	1 1/4"
86203	1 3/4"	1 3/4"

#### Finish Options:



US3



US7



US10B



US14



US15



US15A



US19



US26



US3NL

Traditional



### a. Providence Knob

Product Code	Dimension	Projection
86013	1"	1"
86014	1 1/4"	1 1/8"
86027	1 3/4"	1 1/2"

### b. Waverly Knob

Product Code	Dimension	Projection
86114	1"	1"
86115	1 1/4"	1 1/8"
86201	1 3/4"	1 1/2"

### c. Norwich Knob

Product Code	Dimension	Projection
86610	1 1/4"	1 1/8"
86611	1 5/8"	1 1/2"

#### Finish Options:



US3



US7



US10B



US14



US15



US15A



US19



US26



US3NL





### d. Cup Pull

Product Code	C-to-C	Overall	Height	Projection
86123	3"	4 1/4"	1 1/4"	1 1/8"
86173	4"	5 1/4"	1 1/2"	1 1/2"

### e. Wire Pull

Product Code	C-to-C	Overall	Projection
86131	3"	3 1/4"	1 1/4"
86132	3 1/2"	3 3/4"	1 1/4"
86133	4"	4 1/4"	1 1/4"
86249	6"	6 1/4"	1 1/4"

### f. Spindle Pull

Product Code	C-to-C	Overall	Projection
86128	3"	3 1/2"	1 1/4"
86129	3 1/2"	4 1/8"	1 1/4"
86130	4"	4 1/2"	1 1/4"
86248	6"	6 1/2"	1 1/4"

### g. Egg Knob

Product Code	Dimension	Projection
86015	1"	1"
86016	1 1/4"	1 1/4"
86124	1 3/4"	1 5/8"

Traditional



### a. Round Dimpled Knob

Product Code    Dimension    Projection

86037	1 1/4"	1 1/4"
86213	1 3/4"	1 1/2"

### b. Mortise & Tenon Pull

Product Code    C-to-C    Overall    Projection

86043	3"	3 3/8"	1 1/8"
86044	3 1/2"	3 7/8"	1 1/8"
86045	4"	4 3/8"	1 1/8"
86276	6"	6 3/8"	1 1/8"

### c. Square Dimpled Knob

Product Code    Dimension    Projection

86038	1"	3/4"
86039	1 1/4"	1"
86212	1 3/4"	1 1/8"

Finish Options:



US4



US10B



US15



US3NL



#### **d. Hammered Bin Pull**

Product Code	C-to-C	Overall	Height	Projection
86049	3"	3 1/2"	1 1/2"	1"

#### **e. Hammered Pull**

Product Code	C-to-C	Overall	Projection
86046	3"	3 7/8"	1"
86047	3 1/2"	4 3/8"	1"
86048	4"	4 7/8"	1"

#### **f. Hammered Oval Pull**

Product Code	Dimension
86041	3" x 1 3/4"

#### **g. Hammered Ring Pull**

Product Code	Overall
86040	1 3/4" x 1 1/2"

#### **h. Hammered Vertical Ring Pull**

Product Code	C-to-C	Overall
86042	1 1/2"	1 1/4" x 3 1/2"



### a. Ribbon & Reed Back Plate for Pull

Product Code	Dimension	Overall	Thickness
86294	4"	6 3/4" x 1 1/4"	1/8"

### b. Ribbon & Reed Back Plate for Knob

Product Code	Overall	Thickness
86293	2 1/2" x 1 1/4"	1/8"

### c. Ribbon & Reed Knob

Product Code	Dimension	Projection
86277	1 1/4"	1 1/4"
86278	1 3/4"	1 1/2"

#### Finish Options:



US3



US7



US10B



US15



US15A



US26



US3NL



#### **d. Ribbon & Reed Fixed Pull**

Product Code	C-to-C	Overall	Projection
86283	3"	3 <sup>5</sup> / <sub>8</sub> "	1 <sup>1</sup> / <sub>4</sub> "
86284	3 <sup>1</sup> / <sub>2</sub> "	4 <sup>1</sup> / <sub>8</sub> "	1 <sup>1</sup> / <sub>4</sub> "
86285	4"	4 <sup>5</sup> / <sub>8</sub> "	1 <sup>1</sup> / <sub>4</sub> "
86286	6"	6 <sup>5</sup> / <sub>8</sub> "	1 <sup>1</sup> / <sub>4</sub> "
86287	10"	10 <sup>5</sup> / <sub>8</sub> "	1 <sup>3</sup> / <sub>8</sub> "

**Ribbon & Reed**



ELEMENTS OF

FARROW & BALL HOW TO DECORATE

DELLAYORE INTERIOR DESIGN MASTER





## a. Modern Glass Bar Pull

Product Code	C-to-C	Overall	Projection
86724	4"	6"	1¾"

## b. Modern Glass T-Knob

Product Code	Dimension	Projection
86723	2½"	1¾"

## c. Modern Glass Pull

Product Code	C-to-C	Overall	Projection
86725	4"	4¾"	1⅞"

### Base Options





### a. Grayson Glass Knob

Product Code	Dimension	Projection
86569	1 1/4"	1 1/8"
86570	1 3/4"	1 1/4"

### b. Lido Glass Knob

Product Code	Dimension	Projection
86403	1 3/8"	1 3/8"
86404	1 5/8"	1 1/2"

### c. Bristol Glass Knob

Product Code	Dimension	Projection
86394	1"	1 3/8"
86395	1 1/4"	1 5/8"

#### Brass Options:



US3

US4



US7

US10B



US14

US15



US15A

US19



US26

US3NL





## d. Brookmont Glass Knob

Product Code	Dimension	Projection
86396	1"	1 1/4"
86397	1 1/4"	1 1/2"
86398	1 5/8"	1 3/4"

## e. Forza Glass Knob

Product Code	Dimension	Projection
86565	1 1/4"	1 1/4"

## f. Juneau Glass Knob

Product Code	Dimension	Projection
86562	1 1/8"	1 3/8"

### Brass Options:



US3



US4



US7



US10B



US14



US15



US15A



US19



US26



US3NL



### a. Providence Glass Knob

Product Code	Dimension	Projection
86567	1 3/8"	1 3/8"
86568	1 3/4"	1 1/2"

### b. Hampton Glass Knob

Product Code	Dimension	Projection
86401	1 1/4"	1 3/8"
86402	1 3/4"	1 5/8"

#### Brass Options:



US3



US4



US7



US10B



US14



US15



US15A



US19



US26



US3NL



### c. Deco Glass Knob

Product Code	Dimension	Projection
86563	1 1/4"	1 3/8"
86564	1 5/8"	1 5/8"

### d. Windsor Glass Knob

Product Code	Dimension	Projection
86566	1 5/8" x 1 1/8"	1 1/4"

### e. Lowell Glass Knob

Product Code	Dimension	Projection
86571	1 3/8"	1 1/4"

#### Brass Options:



US3



US4



US7



US10B



US14



US15



US15A



US19



US26



US3NL



### a. Old Town Wardrobe Glass Knob

Product Code	Dimension	Projection
86028	1 3/4"	1 1/2"

### b. Old Town Glass Knob

Product Code	Dimension	Projection
86010	1"	7/8"
86011	1 1/4"	1 1/8"

### c. Georgetown Glass Knob

Product Code	Dimension	Projection
86399	1 1/4"	1 1/2"
86400	1 3/4"	1 3/4"

#### Brass Options:



US3



US4



US7



US10B



US14



US15



US15A



US19



US26



US3NL



### d. Astoria Glass Knob\*

Product Code	Dimension	Projection
86017	1 1/8"	1 1/8"
86210	1 1/2"	1 1/2"

\* Finish options are not available for this product.

### e. Diamond Wardrobe Glass Knob

Product Code	Dimension	Projection
86209	1 3/4"	2"

### f. Diamond Glass Knob

Product Code	Dimension	Projection
86003	1"	1 3/8"
86012	1 1/4"	1 7/8"

#### Brass Options:



US3



US4



US7



US10B



US14



US15



US15A



US19



US26



US3NL

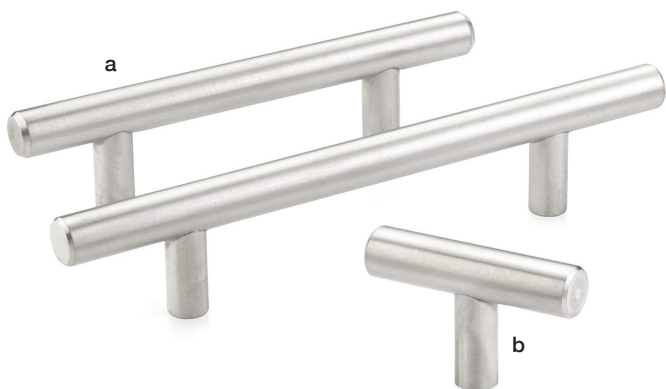

### a. Bar Pull

Product Code	C-to-C	Overall	Projection
S62002SS	3"	5"	1 1/4"
S62003SS	3 1/2"	5 1/2"	1 1/4"
S62004SS	4"	6 1/2"	1 1/4"
S62005SS	5"	7 1/2"	1 1/4"
S62006SS	6"	8 1/2"	1 1/4"
S62007SS	8"	10 1/2"	1 1/4"
S62008SS	10"	12 1/2"	1 1/4"
S62009SS	12"	14 1/2"	1 1/4"
S62010SS	16"	18 1/2"	1 1/4"
S62011SS	24"	26 1/2"	1 1/4"
S62012SS	28"	30 1/2"	1 1/4"
S62013SS	32"	34 1/2"	1 1/4"
S62014SS	36"	38 1/2"	1 1/4"

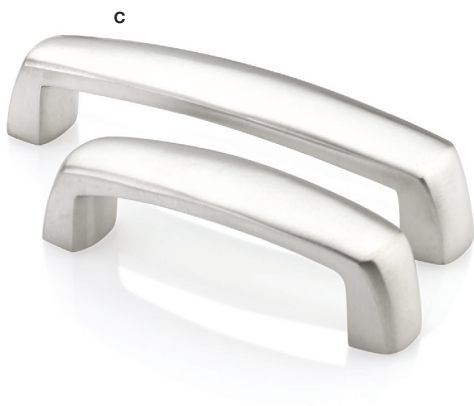

### **b. Bar Knob**

Product Code	Dimension	Projection
S62001SS	2"	1 1/4"

### **c. Delta Pull**

Product Code	C-to-C	Overall	Projection
S60030SS	3"	3 1/2"	1"
S60035SS	3 1/2"	4"	1"
S60040SS	4"	4 1/2"	1"

Finish Option:



*Stainless Steel (SS)*

**Stainless Steel**

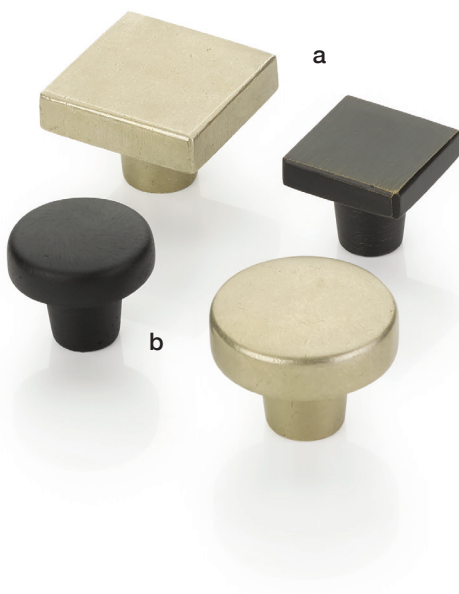

### a. Rustic Modern Square Knob

Product Code	Dimension	Projection
86662	1 ¼"	1 ⅛"
86663	1 ⅝"	1 ¼"

### b. Rustic Modern Round Knob

Product Code	Dimension	Projection
86660	1 ⅜"	1 ¼"
86661	1 ¾"	1 ⅜"

#### Finish Options:



FB



MB



TWB



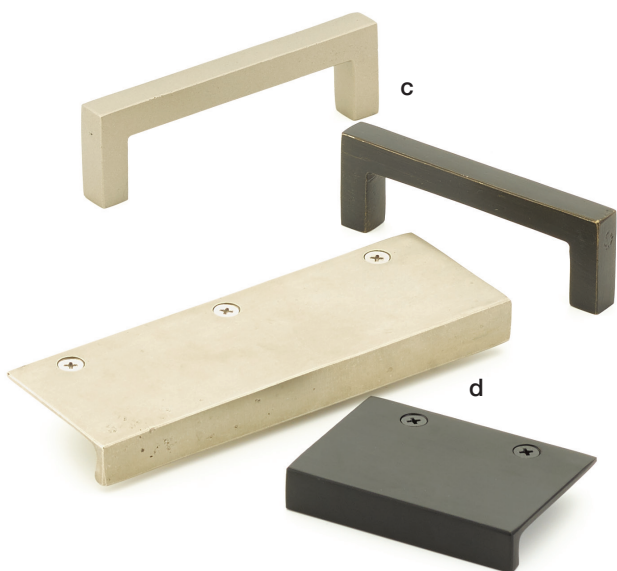

### c. Rustic Modern Pull

Product Code	C-to-C	Overall	Projection
86667	3 1/2"	4"	1 3/8"
86668	4"	4 1/2"	1 3/8"
86669	5"	5 1/2"	1 3/8"
86670	6"	6 1/2"	1 3/8"
86671	8"	8 1/2"	1 3/8"
86672	10"	10 1/2"	1 3/8"
86673	12"	12 1/2"	1 3/8"

### d. Rustic Modern Edge Pull

Product Code	C-to-C	Overall	Projection
86664	1 1/2"	3"	2 1/8"
86665	4 1/2"	6"	2 1/8"
86666	10 1/2"	12"	2 1/8"

Rustic Modern

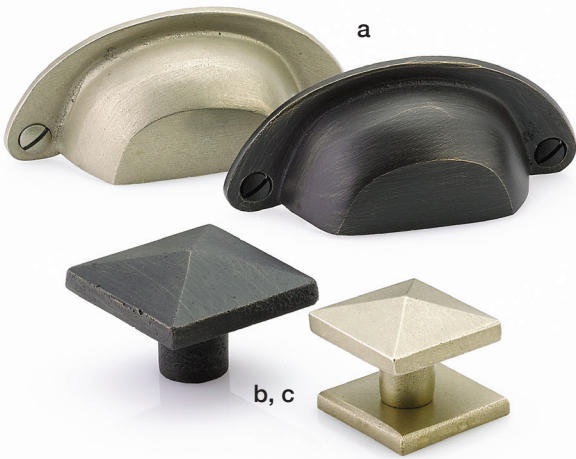

### a. Ranch Bin Pull

Product Code	C-to-C	Overall	Projection
86326	3"	3 1/2"	1"
86327	4"	4 5/8"	1"

### b. Square Knob

Product Code	Dimension	Projection
86145	1 1/4"	1"
86146	1 5/8"	1 1/8"

### c. Square Back Plate for Knob

Product Code	Dimension	Thickness
86342	1 1/4"	1/8"

Finish Options:



FB



MB



TWB

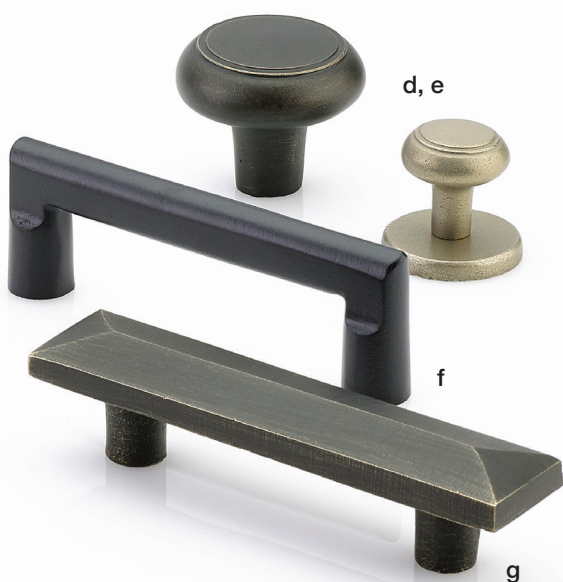

#### **d. Barn Knob**

Product Code	Dimension	Projection
86338	1"	1"
86339	1 1/4"	1 1/8"
86340	1 3/4"	1 1/2"

#### **e. Round Back Plate for Knob**

Product Code	Dimension	Thickness
86341	1 1/4"	1/8"

#### **f. Rail Pull**

Product Code	C-to-C	Overall	Projection
86332	3"	3 1/2"	1 1/4"
86333	3 1/2"	4 1/8"	1 1/4"
86334	4"	4 1/2"	1 1/4"
86335	6"	6 1/2"	1 3/8"
86336	8"	8 1/2"	1 3/8"
86337	10"	10 1/2"	1 3/8"

#### **g. Pyramid Pull**

Product Code	C-to-C	Overall	Projection
86328	3"	4 1/2"	1"
86329	3 1/2"	5"	1"
86330	4"	5 1/2"	1"
86331	6"	7 1/2"	1 1/8"

Sandcast Bronze

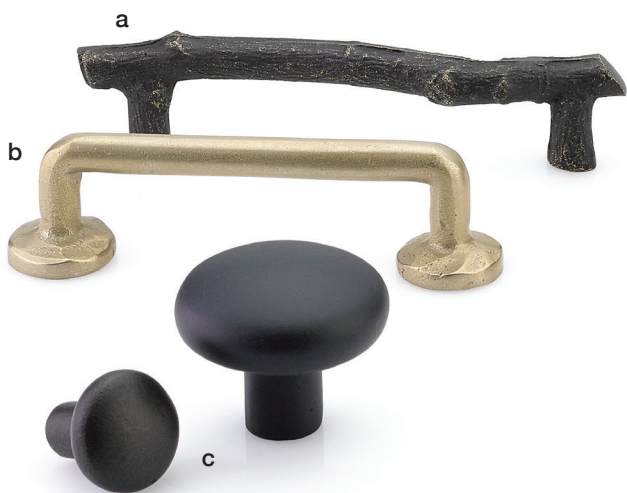

### a. Twig Pull

Product Code	C-to-C	Overall	Projection
86061	3"	4 1/8"	1 1/4"
86062	3 1/2"	4 1/2"	1 1/4"
86063	4"	4 7/8"	1 1/4"
86252	6"	7 3/8"	1 1/4"

### b. Rod Pull

Product Code	C-to-C	Overall	Projection
86054	3"	4"	1 1/4"
86055	3 1/2"	4 1/2"	1 1/4"
86056	4"	5"	1 1/4"
86253	6"	7"	1 1/4"

### c. Round Knob

Product Code	Dimension	Projection
86057	1"	1"
86058	1 1/4"	1 1/8"
86117	1 3/4"	1 1/2"



#### d. Bin Pull

Product Code	C-to-C	Overall	Height	Projection
86051	3"	3 <sup>3</sup> / <sub>8</sub> "	1 1/2"	1"
86050	4"	4 1/2"	1 <sup>5</sup> / <sub>8</sub> "	1"

#### e. Egg Knob

Product Code	Dimension	Projection
86052	1"	1"
86053	1 1/4"	1 1/4"
86217	1 <sup>3</sup> / <sub>4</sub> "	1 <sup>5</sup> / <sub>8</sub> "

#### f. Round Back Plate for Knob

Product Code	Dimension	Thickness
86341	1 1/4"	1/8"

Finish Options:



FB



MB



TWB

Sandcast Bronze



### a. Twist Pull

Product Code	C-to-C	Projection
86103	3"	1 1/4"
86104	3 1/2"	1 1/4"
86105	4"	1 1/4"
86238	6"	1 3/8"
86239	8"	1 3/8"
86240	10"	1 3/8"

### b. Back Plate for Pull

Product Code	C-to-C	Overall
86235	3"	5 1/4" x 7/8"
86236	3 1/2"	5 3/4" x 7/8"
86237	4"	6 1/4" x 7/8"

### c. Twist Finger Knob

Product Code	Dimension	Projection
86097	1 3/4"	1 1/4"
86098	3"	1 3/4"

### d. Twist Round Knob

Product Code	Dimension	Projection
86244	1"	1 1/8"
86245	1 1/4"	1 1/4"
86246	1 3/4"	1 1/2"

### e. Back Plate for Knob

Product Code	Dimension	Width
86234	2 1/4"	7/8"

Finish Options:



FB



MB



#### **f. Fluted Bin Pull**

Product Code	C-to-C	Overall	Projection
86232	3"	3 <sup>3</sup> / <sub>8</sub> "	1"
86233	4"	4 <sup>3</sup> / <sub>8</sub> "	1"

#### **g. Fluted Round Knob**

Product Code	Dimension	Projection
86229	1"	1 <sup>1</sup> / <sub>8</sub> "
86230	1 <sup>1</sup> / <sub>4</sub> "	1 <sup>1</sup> / <sub>4</sub> "
86231	1 <sup>3</sup> / <sub>4</sub> "	1 <sup>1</sup> / <sub>2</sub> "

#### **h. Fluted Finger Knob**

Product Code	Dimension	Projection
86227	1 <sup>3</sup> / <sub>4</sub> "	1 <sup>1</sup> / <sub>4</sub> "
86228	3"	1 <sup>5</sup> / <sub>8</sub> "

#### **i. Fluted Pull**

Product Code	C-to-C	Projection
86218	3"	1 <sup>1</sup> / <sub>2</sub> "
86219	3 <sup>1</sup> / <sub>2</sub> "	1 <sup>1</sup> / <sub>2</sub> "
86220	4"	1 <sup>1</sup> / <sub>2</sub> "
86221	6"	1 <sup>1</sup> / <sub>2</sub> "
86222	8"	1 <sup>1</sup> / <sub>2</sub> "
86223	10"	1 <sup>1</sup> / <sub>2</sub> "

Tuscany Bronze



### a. Tuscany Bin Pull

Product Code	C-to-C	Overall	Projection
86099	3"	3 1/2"	1"
86199	4"	4 3/8"	1"

### b. Tuscany Ribbed Pull

Product Code	C-to-C	Overall	Projection
86100	3"	3 5/8"	1"
86101	3 1/2"	4 1/8"	1"
86102	4"	4 5/8"	1"
86255	6"	6 5/8"	1"

### c. Tuscany Petal Knob

Product Code	Dimension	Projection
86095	1"	1"
86096	1 1/4"	1 1/4"
86214	1 3/4"	1 1/2"





### **d. Tuscany Octagon Knob**

Product Code	Dimension	Projection
86137	1"	1"
86138	1 1/4"	1 1/4"
86215	1 3/4"	1 5/8"

### **e. Tuscany Round Knob**

Product Code	Dimension	Projection
86091	1"	1"
86092	1 1/4"	1 1/4"
86116	1 3/4"	1 1/2"

### **f. Tuscany Egg Knob**

Product Code	Dimension	Projection
86093	1"	1"
86094	1 1/4"	1 1/4"
86143	1 3/4"	1 1/2"

Finish Options:



FB



MB

**Tuscany Bronze**



### a. Wrought Steel Bastogne Knob

Product Code    Dimension    Projection

76017	2 <sup>3</sup> / <sub>8</sub> "	1 <sup>1</sup> / <sub>2</sub> "
76018	3 <sup>3</sup> / <sub>8</sub> "	2"

### b. Wrought Steel Flanders Knob

Product Code    Dimension    Projection

76011	1 <sup>1</sup> / <sub>4</sub> "	2"
76012	1 <sup>1</sup> / <sub>2</sub> "	2 <sup>1</sup> / <sub>8</sub> "
76042	2"	2 <sup>1</sup> / <sub>2</sub> "

### c. Wrought Steel Lafayette Pull

Product Code    C-to-C    Overall    Projection

76025	3"	3 <sup>3</sup> / <sub>8</sub> "	1 <sup>1</sup> / <sub>2</sub> "
76019	3 <sup>1</sup> / <sub>2</sub> "	3 <sup>7</sup> / <sub>8</sub> "	1 <sup>1</sup> / <sub>2</sub> "
76020	4"	4 <sup>3</sup> / <sub>8</sub> "	1 <sup>1</sup> / <sub>2</sub> "
76047	6"	6 <sup>3</sup> / <sub>8</sub> "	1 <sup>1</sup> / <sub>2</sub> "

Finish Options:



FBS



SWS



#### **d. Wrought Steel Petal Knob**

Product Code	Dimension	Projection
76013	1"	1 1/4"
76014	1 1/4"	1 3/8"
76044	1 3/4"	1 1/2"

#### **e. Wrought Steel Normandy Pull**

Product Code	C-to-C	Overall	Projection
76027	3"	3 1/2"	1 1/2"
76023	3 1/2"	4"	1 1/2"
76024	4"	4 1/2"	1 1/2"
76046	6"	6 1/2"	1 1/2"

#### **f. Wrought Steel San Carlos Pull**

Product Code	C-to-C	Overall	Projection
76026	3"	3 1/4"	1 1/2"
76021	3 1/2"	3 3/4"	1 1/2"
76022	4"	4 1/4"	1 1/2"
76045	6"	6 1/4"	1 1/2"

#### **g. Wrought Steel Brittany Knob**

Product Code	Dimension	Projection
76015	1"	1 1/8"
76016	1 1/4"	1 3/8"
76043	1 3/4"	1 3/4"

**Wrought Steel**

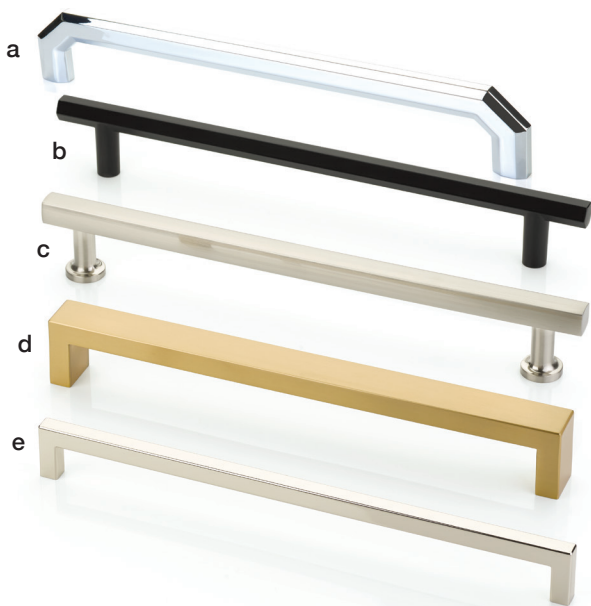

### a. Riviera Appliance Pull

Product Code	C-to-C	Overall	Projection
86621	12"	12 7/8"	2"
86622	18"	18 7/8"	2"

### b. Mod Hex Appliance Pull

Product Code	C-to-C	Overall	Projection
87003	12"	14 3/4"	2"
87004	18"	20 5/8"	2 1/8"

### c. Freestone Appliance Pull

Product Code	C-to-C	Overall	Projection
87001	12"	14"	2"
87002	18"	20"	2"

### d. Keaton Appliance Pull

Product Code	C-to-C	Overall	Projection
86721	12"	12 1/2"	1 3/4"
86722	18"	18 1/2"	1 3/4"

### e. Warwick Appliance Pull

Product Code	C-to-C	Overall	Projection
86711	12"	12 1/2"	1 3/4"
86712	18"	18 1/2"	1 3/4"

Finish Options:



US4



US10B



US14



US15



US19



US26



#### **f. Westridge Appliance Pull**

Product Code	C-to-C	Overall	Projection
86640	12"	13 1/8"	2"
86641	18"	19 1/8"	2"

#### **g. Tribeca Appliance Pull**

Product Code	C-to-C	Overall	Projection
87005	12"	15"	2 1/8"
87006	18"	21"	2 1/8"

#### **h. Jasper Appliance Pull**

Product Code	C-to-C	Overall	Projection
86693	12"	13 3/8"	1 7/8"
86694	18"	19 3/8"	1 7/8"

#### **i. Trinity Appliance Pull**

Product Code	C-to-C	Overall	Projection
86444	12"	12 7/8"	1 3/4"
86445	18"	19 1/8"	1 3/4"

#### **j. Alexander Appliance Pull**

Product Code	C-to-C	Overall	Projection
86442	12"	13"	2"
86443	18"	19"	2"

# Appliance Pulls

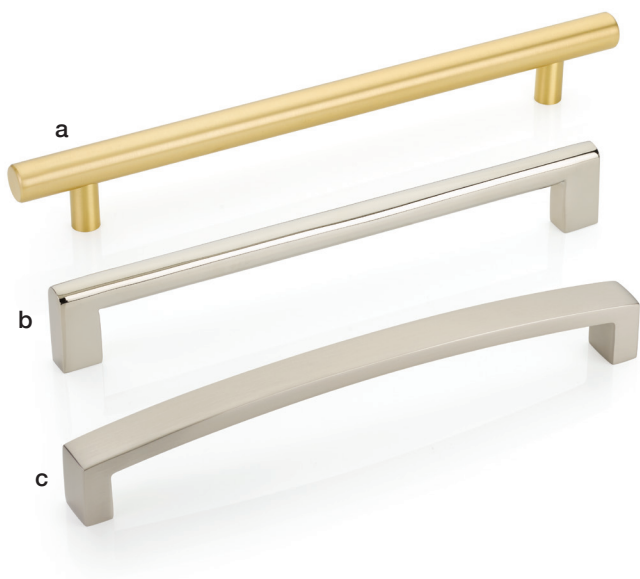

### a. Bar Appliance Pull

Product Code	C-to-C	Overall	Projection
86351	12"	15 1/4"	2"
86352	18"	21 1/4"	2"

### b. Trail Appliance Pull

Product Code	C-to-C	Overall	Projection
86440	12"	13"	2"
86441	18"	19"	2"

### c. Bauhaus Appliance Pull

Product Code	C-to-C	Overall	Projection
86345	12"	12 5/8"	1 7/8"
86346	18"	18 5/8"	1 7/8"

Finish Options:



US4



US10B



US14



US15



US19



US26



US3NL



#### d. Blythe Appliance Pull

Product Code	C-to-C	Overall	Projection
86910	12"	13"	2"
86911	18"	19"	2"

#### e. Westwood Appliance Pull

Product Code	C-to-C	Overall	Projection
86912	12"	13"	2 1/8"
86913	18"	19"	2 1/8"

Finish Options:



US4



US10B



US14



US15



US19



US26

#### f. Spindle Appliance Pull

Product Code	C-to-C	Overall	Projection
86343	12"	14 5/8"	2 1/8"
86344	18"	20 5/8"	2 1/8"

Finish Options:



US3



US7



US10B



US14



US15



US15A



US19



US26



US3NL

# Appliance Pulls



### a. Sandcast Bronze Rustic Modern Rectangular Appliance Pull

Product Code	C-to-C	Overall	Projection
86674	12"	12 5/8"	1 3/4"
86675	18"	18 5/8"	1 3/4"

### b. Sandcast Bronze Rail Appliance Pull

Product Code	C-to-C	Overall	Projection
86349	12"	12 3/4"	2"
86350	18"	18 3/4"	2"

Finish Options:



FB



MB



TWB

### c. Tuscany Bronze Fluted Appliance Pull

Product Code	C-to-C	Overall	Projection
86347	12"	12 7/8"	2"
86348	18"	18 7/8"	2"

Finish Options:



FB



MB



# Bath Hardware



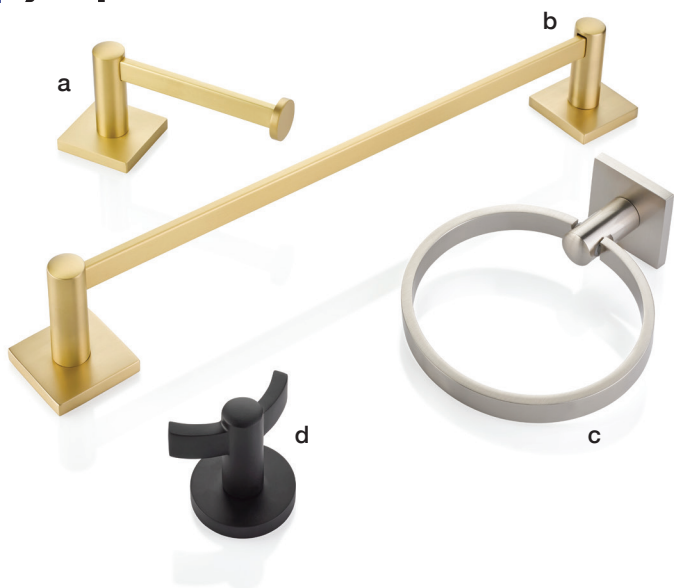

## MODERN BRASS

### a. Modern Brass Paper Holder - Bar Style

Product Code	Overall	Projection
2804	6 <sup>3</sup> / <sub>8</sub> "	2 <sup>7</sup> / <sub>8</sub> "

### b. Modern Brass Towel Bar

Product Code	Overall	Projection
28024	12"	3 <sup>1</sup> / <sub>4</sub> "
28021	18"	3 <sup>1</sup> / <sub>4</sub> "
28022	24"	3 <sup>1</sup> / <sub>4</sub> "
28023	30"	3 <sup>1</sup> / <sub>4</sub> "

### c. Modern Brass Towel Ring

Product Code	Overall	Projection
2801	6 <sup>1</sup> / <sub>2</sub> "	2 <sup>5</sup> / <sub>8</sub> "

### d. Modern Brass Double Hook

Product Code	Overall	Projection
2809	3 <sup>5</sup> / <sub>8</sub> "	2 <sup>7</sup> / <sub>8</sub> "

#### Rosette Options:



Disk



Modern Rectangular



Neos



Square



Urban Modern



Small Disc

#### Finish Options:



US4



US10B



US14



US15



US19



US26



US3NL

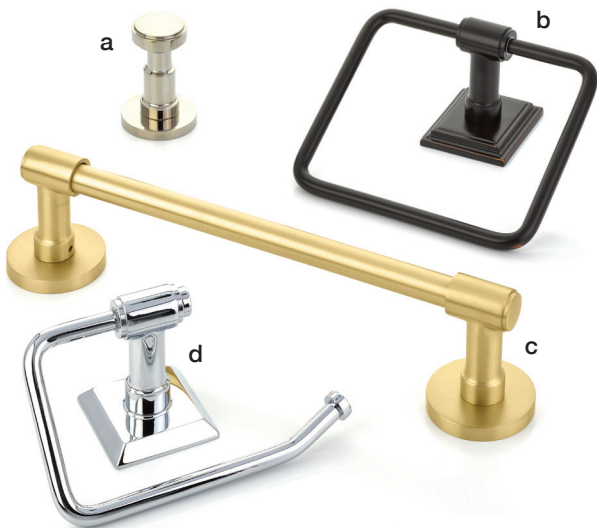

## TRANSITIONAL BRASS

### a. Transitional Brass Single Hook

Product Code	Overall	Projection
2909	2 3/8"	2 7/8"

### b. Transitional Brass Towel Ring

Product Code	Overall	Projection
2901	7"	3 1/2"

### c. Transitional Brass Towel Bar

Product Code	Overall	Projection
29025	12"	3 1/4"
29026	18"	3 1/4"
29027	24"	3 1/4"
29028	30"	3 1/4"

### d. Transitional Brass Paper Holder - Bar Style

Product Code	Overall	Projection
2904	6 7/8"	3 3/8"

#### Rosette Options:



Disk



Square



Quincy



Wilshire



Small  
Regular



Small  
Disc

#### Finish Options:



US4



US10B



US14



US15



US19



US26



US3NL



## TRADITIONAL BRASS

### a. Brass Double Towel Bar

Product Code	Overall	Projection
26031	18"	5 <sup>3</sup> / <sub>8</sub> "
26032	24"	5 <sup>3</sup> / <sub>8</sub> "
26033	30"	5 <sup>3</sup> / <sub>8</sub> "

### b. Brass Towel Ring

Product Code	Overall	Projection
2601	6 <sup>7</sup> / <sub>8</sub> "	2 <sup>5</sup> / <sub>8</sub> "

### c. Brass Double Hook

Product Code	Overall	Projection
2609	3 <sup>3</sup> / <sub>8</sub> "	2 <sup>7</sup> / <sub>8</sub> "

### d. Brass Robe Hook

Product Code	Overall	Projection
2606	4"	2 <sup>5</sup> / <sub>8</sub> "

### e. Brass Double Hook

Product Code	Overall	Projection
2607	3 <sup>1</sup> / <sub>2</sub> "	2 <sup>1</sup> / <sub>8</sub> "

### f. Brass Towel Bar

Product Code	Overall	Projection
26024	12"	3 <sup>3</sup> / <sub>8</sub> "
26021	18"	3 <sup>3</sup> / <sub>8</sub> "
26022	24"	3 <sup>3</sup> / <sub>8</sub> "
26023	30"	3 <sup>3</sup> / <sub>8</sub> "

### g. Brass Paper Holder - Spring Rod Style

Product Code	Overall	Projection
2605	7 <sup>1</sup> / <sub>8</sub> "	3 <sup>3</sup> / <sub>8</sub> "

### h. Brass Paper Holder - Bar Style

Product Code	Overall	Projection
2604	6 <sup>3</sup> / <sub>4</sub> "	3 <sup>3</sup> / <sub>8</sub> "

### i. Brass Single Hook

Product Code	Projection
2608	3 <sup>1</sup> / <sub>2</sub> "



Rosette Options:



Finish Options:

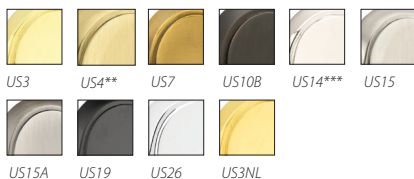

\* Not Available in US3, US7, and US15A finishes.

\*\* Satin Brass (US4) available in Brass Robe Hook only.

\*\*\* Polished Nickel-Lifetime (US14) available in Regular, Rectangular, #8, Quincy, Wilshire, Disk, Square, Modern Rectangular, Small Disc, and Small Regular Rosettes only.

† Arts & Crafts Rosette available in US10B, US15, US19 and US3NL finishes only.

‡ Not Available in Flat Black (US19) finish.



## SANDCAST BRONZE

### a. Sandcast Bronze Towel Bar

Product Code	Overall	Projection
23024	12"	3 5/8"
23021	18"	3 5/8"
23022	24"	3 5/8"
23023	30"	3 5/8"

### b. Sandcast Bronze Paper Holder - Bar Style

Product Code	Overall	Projection
2303	6 1/2"	3"

### c. Sandcast Bronze 3 Hooks with Rectangular Plate

Product Code	Overall	Projection
2307	9 1/2" x 2" 2 1/2"	

### d. Sandcast Bronze Robe Hook

Product Code	Overall	Projection
86106	3 7/8"	2 1/2"

### e. Sandcast Bronze Double Hook

Product Code	Overall	Projection
2306	3 1/4"	2 1/8"

### f. Sandcast Bronze Paper Holder - Spring Rod Style

Product Code	Overall	Projection
2304	7 1/4"	3"



### g. Sandcast Bronze Double Towel Bar

Product Code	Overall	Projection
23051	18"	5 1/2"
23052	24"	5 1/2"
23053	30"	5 1/2"

### h. Sandcast Bronze Single Hook

Product Code	Projection
2308	2 3/4"

### i. Sandcast Bronze Towel Ring

Product Code	Overall	Projection
2301	6 1/2"	3"

#### Finish Options:



FB



MB



TWB

#### Rosette Options:



#1



#2



#3



#4



#6

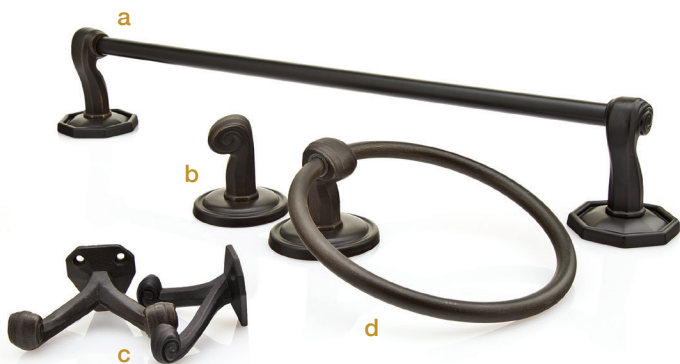

## TUSCANY BRONZE

### a. Tuscany Bronze Towel Bar

Product Code	Overall	Projection
27024	12"	3 <sup>3</sup> / <sub>8</sub> "
27021	18"	3 <sup>3</sup> / <sub>8</sub> "
27022	24"	3 <sup>3</sup> / <sub>8</sub> "
27023	30"	3 <sup>3</sup> / <sub>8</sub> "

### b. Tuscany Bronze Single Hook

Product Code	Projection
2706	2 <sup>3</sup> / <sub>4</sub> "

### c. Tuscany Bronze Double Hook

Product Code	Overall	Projection
2707	3 <sup>3</sup> / <sub>8</sub> "	2 <sup>1</sup> / <sub>4</sub> "

### d. Tuscany Bronze Towel Ring

Product Code	Overall	Projection
2701	6 <sup>1</sup> / <sub>2</sub> "	2 <sup>5</sup> / <sub>8</sub> "





### e. Tuscany Bronze Double Towel Bar

Product Code	Overall	Projection
27081	18"	5 3/8"
27082	24"	5 3/8"
27083	30"	5 3/8"

### f. Tuscany Bronze Paper Holder - Bar Style

Product Code	Overall	Projection
2705RH	6 1/4"	3"
2705LH	6 1/4"	3"

### g. Tuscany Bronze Paper Holder - Spring Rod Style

Product Code	Overall	Projection
2704	7 1/8"	3"

#### Rosette Options:



#11



#12



#14



#15

#### Finish Options:



FB



MB



## WROUGHT STEEL

### a. Wrought Steel Paper Holder - Bar Style

Product Code	Overall	Projection
2503	8 1/8"	3 3/8"

### b. Wrought Steel Robe Hook

Product Code	Overall	Projection
25050	3 3/4"	3"

### c. Wrought Steel Towel Bar

Product Code	Overall	Projection
25024	12"	3 3/8"
25021	18"	3 3/8"
25022	24"	3 3/8"
25023	30"	3 3/8"

### d. Wrought Steel Paper Holder - Spring Rod Style

Product Code	Overall	Projection
2504	9 3/8"	3 3/8"

### e. Wrought Steel Towel Ring

Product Code	Overall	Projection
2501	6 1/2"	2 5/8"

#### Rosette Options:



#1



#2



#3

#### Finish Options:



FBS



SWS

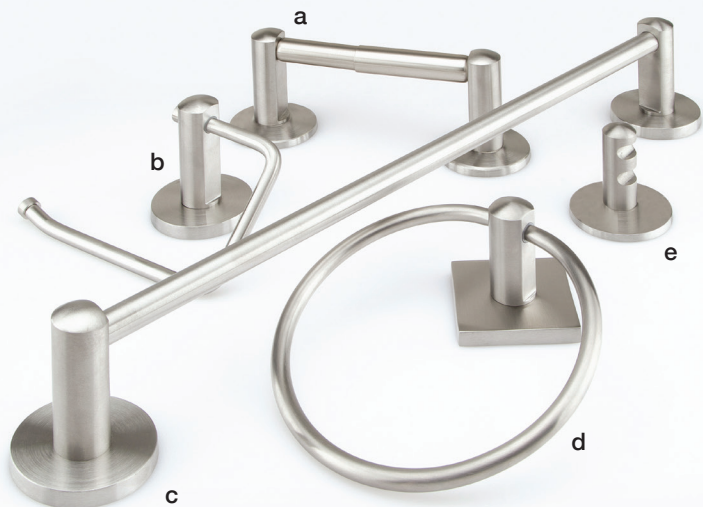

## STAINLESS STEEL

### a. Stainless Steel Paper Holder - Spring Rod Style

Product Code	Overall	Projection
S7220	8 1/2"	3 3/8"

#### Rosette Options:



Disk

### b. Stainless Steel Paper Holder - Bar Style

Product Code	Overall	Projection
S7210	6 3/8"	3 1/8"



Square

### c. Stainless Steel Towel Bar

Product Code	Overall	Projection
S7040	12"	3 1/4"
S7010	18"	3 1/4"
S7020	24"	3 1/4"
S7030	30"	3 1/4"

#### Finish Option:



SS

### d. Stainless Steel Towel Ring

Product Code	Overall	Projection
S7300	6 7/8"	2 3/4"

### e. Stainless Steel Single Hook

Product Code	Projection
S71001	2 5/8"

# EMTEK®

EMTEK Products

Tel: 800-356-2741 • 626-961-0413

Fax: 800-577-5771 • 626-336-2812

[emtek.com](http://emtek.com)

Copyright © Emtek Products. Reproduction in whole or in part without the express written permission of Emtek Products is prohibited.

BX4-BROCHURE7  
MARCH 2023